

/// BECOTECHNIC

ERGOLIFT



ERGOLIFT EVOLUTION

**EVOLVE YOUR WORKSHOP
ELEVATE YOUR WORK**

ABOUT ERGOLIFT EVOLUTION

Ob für den Uhrmacher oder Goldschmied – diese Werkische überzeugen!

Denn die elektrisch höhenverstellbaren Tische der Serie Ergolift Evolution passen sich nicht nur Ihren Ansprüchen an, sondern ihr ergonomisches Design entlastet den Oberkörper und sorgt für Wohlbefinden und Leistungsvermögen.

Bereits in der Basisversion haben Sie die Wahl zwischen 3 Tischbreiten und 3 Materialkombinationen. Zusätzlich lassen sich optionale Ausstattungen modular hinzuwählen – beim initialen Kauf oder auch zu einem späteren Zeitpunkt als nachträgliche Ergänzung.

Whether for the watchmaker or goldsmith - these workbenches are convincing!

The electrically height-adjustable benches of the Ergolift Evolution series not only adapt to your requirements, but their ergonomic design relieves the upper body and ensures well-being and performance.

Even with the basic version, you can choose between 3 bench widths and 3 material combinations. In addition, you can select optional equipment on a modular basis – either at the time of the initial purchase or at a later date as a subsequent addition.



Für Ihre individuellen Einkaufspreise wenden Sie sich bitte an Ihren Händler.

For your individual purchase prices, please get in touch with your distributor.



Für Uhrmacher S. 3
For watchmakers p. 3



Für Goldschmiede S. 23
For goldsmiths p. 23



Beistellmöbel S. 36
Side furnitures p. 36

ERGOLIFT EVOLUTION WATCH



Werkische und Sonderausstattungen für Uhrmacher
Workbenches and optional equipments for watchmakers

Ergolift Evolution Watch



- Integrierter Adapter für Arbeitsplatzleuchten
Integrated adapter for task luminaires
- Schutzscheibe aus ESG Floatglas
Protection washer made of ESG float glass
- Universalbohrungen für Druckluft-Vakuum-Verteiler, Regalaufsätze oder Kabeldurchlässe
Universal holes for compressed-air-vacuum-distributors, shelf attachments, or cable passes
- Umlaufendes Hartgummiprofil, Rillen oder Kanten zum Auffangen von Kleinteilen
Circumferential hard rubber profile, grooves or raised edges to catch small parts
- Verschiedene Bedienelemente und App-Steuerung
Various controls and app control
- Eingelassene Nutenplatten für Schraubstöcke
Recessed grooved plates for vises
- Extrem strapazierfähige HPL-Arbeitsplatten nach Industriestandard oder Massivholzplatten, lackiert oder geölt
Extremely durable industrial standard HPL or solid wood benchtops, lacquered or oiled
- Schubladen mit Soft-Close-Dämpfern, Vollauszug, Zentralverriegelung und unterschiedlichen Einteilungsmaterialien
Drawers with soft-close dampers, full-extension, central locking, and various dividing materials
- 7 verschiedene Armauflagen
7 different armrests
- Ablageplatten, Schubladenerweiterungen, Mittelschubladen und Tablare für mehr Stauraum und bessere Arbeitsabläufe
Storage shelves, drawer extensions, central drawers, and pull-out shelves for more storage space and improved workflows
- Rückwärtiges Fach unter der Tischplatte und doppelte Rückwand zur Kabelführung
Rear panel beneath the benchtop and double back panel for cable routing

Ergolift Evolution Watch



Basismodelle

Bereits die Basismodelle des Ergolift Evolution sind mit vielen Komponenten ausgestattet:

- Elektrische Höhenverstellung
- 2D Armauflagen
- Kabelführung unter der Arbeitsplatte
- Universalbohrungen für Druckluft-Vakuum-Verteiler, Regalaufsätze oder Kabeldurchlass
- Integrierter Adapter für eine Arbeitsplatzleuchte
- Eingelassene Nutenplatten für Schraubstöcke

Basic models

Even the basic models of the Ergolift Evolution are equipped with many components:

- Electrically height adjustable
- 2D armrests
- Cable routing beneath the benchtop
- Universal holes for compressed-air-vacuum-distributor, shelf attachments, or cable pass
- Built-in adapter for a luminaire
- Recessed grooved plates for vises

MORE THAN A FEELING

Ergolift Evolution Watch



Elektrisch höhenverstellbar

Schon die Basismodelle verfügen über die elektrische Höhenverstellung. Über ein Steuerelement, das an der Unterseite der Tischplatte angebracht ist, wird die Höhe mühelos, stufenlos und ruckel-frei verstellt.

Der elektrische Antrieb verzichtet aus Sicherheitsgründen auf eine Antriebswelle unter der Arbeitsplatte und überzeugt durch eine fünfjährige Gewährleistung auf Herstellungsfehler.

Electrically height adjustable

Even the basic models feature electric height adjustment. A control element mounted on the underside of the benchtop adjusts the height effortlessly, continuously, and smoothly.

For safety reasons, the electric drive does not have a driveshaft under the benchtop and comes with a five-year warranty against manufacturing defects.

LIFT
ME UP

90 - 156 cm



Ergolift Evolution Watch



				Gestell Frame	N°	Listenpreis List price
100 cm	120 cm	17 x 53 cm	26 x 53 cm			
100 cm		17 x 53 cm		■ Schwarz Black	309770	
120 cm	■ Weiß White	26 x 53 cm	■ Weiß White		309780	
140 cm		35 x 53 cm			309740	
100 cm		17 x 53 cm		■ Buche Beech	309870	
120 cm	■ Buche Beech	26 x 53 cm	■ Buche Beech		309880	
140 cm		35 x 53 cm			309791	
100 cm		17 x 53 cm		■ Seidengrau Silk gray	309898	
120 cm	■ Eiche Oak	26 x 53 cm	■ Seidengrau Silk gray		309897	
140 cm		35 x 53 cm			309649	



Ergolift Evolution Watch

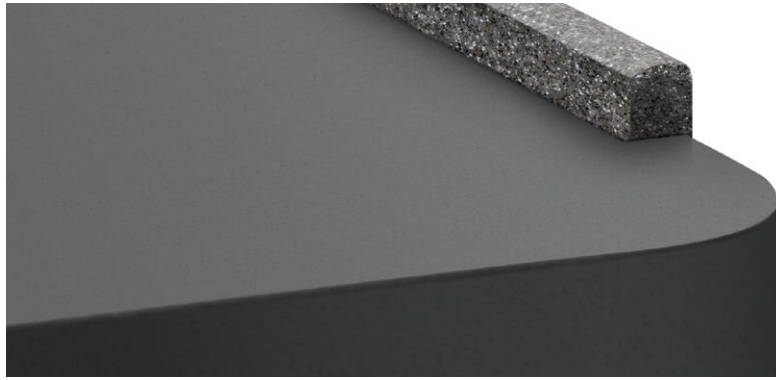



Softstop-Arbeitsplatten, vollflächig

Die Arbeitsplatten sind vollflächig mit einem Softstop-Belag versehen und haben an 3 Seiten Kanten aus Mineralwerkstoff.

Softstop benchtops, fully covered

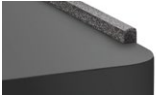
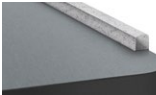
The benchtops are fully covered with a softstop coating and have raised edges made of solid surface material on 3 sides.

	Softstop	Kante Raised edge	Einfassung Edging	Diagram			N°	Aufpreis Surcharge
				100	120	140		
 Dunkelgrau Dark gray	[Dark gray square]	[Dark gray square]	[Black square]	●	-	-	309782	[Info icon]
				-	●	-	309785	
				-	-	●	309786	
 Grau Gray	[Gray square]	[Gray square]	[Black square]	●	-	-	309834	
				-	●	-	309835	
				-	-	●	309836	
 Hellgrau Light gray	[Light gray square]	[White square]	[Black square]	●	-	-	309837	
				-	●	-	309838	
				-	-	●	309839	
 Hellgrün Light green	[Light green square]	[White square]	[Black square]	●	-	-	309840	
				-	●	-	309841	
				-	-	●	309842	

Ergolift Evolution Watch



Softstop-Arbeitsplatten, partiell



Die Arbeitsplatten sind teilweise mit einem Softstop-Belag versehen. Der Arbeitsbereich und die Kanten bestehen aus Mineralwerkstoff.

Softstop benchtops, partially covered

The benchtops are partially covered with a softstop coating. The working area and the raised edges are made of solid surface material.

Zusätzlich gibt es eine Auffangfräsung für Kleinteile und 2 eingelassene Nutenplatten (120 und 140).

In addition, there is a groove to catch small parts and 2 recessed groove plates (120 and 140).

	Softstop	Kante Raised edge	Basis Base	Diagram			N°	Aufpreis Surcharge
				100	120	140		
 Hellgrau Light gray	[Light gray square]	[White square]	[Brown square]	●	-	-	309843	[Info icon]
				-	●	-	309844	
				-	-	●	309804	
 Hellgrün Light green	[Light green square]	[White square]	[Brown square]	●	-	-	309846	
				-	●	-	309847	
				-	-	●	309848	

SOFT **STOP**
IN THE NAME OF LOVE

Ergolift Evolution Watch



Ergolift Evolution Watch



Armauflagen

Armauflagen tragen in hohem Maße zur Ergonomie eines Arbeitsplatzes bei. Sie entlasten Nacken, Schultern, Unterarme und Rücken und helfen so Verspannungen und Rückenschmerzen zu reduzieren.

Armrests

Armrests contribute significantly to the ergonomics of a workstation. They take the strain off the neck, shoulders, forearms, and back, helping to reduce tension and back pain.

					N°	Aufpreis Surcharge
		100	120	140		
Armauflagen mit Halterung <i>Armrests with mount</i>		•	•	•	309749	-
Armauflagen Mikrofaser, schwarz <i>Armrests microfiber, black</i>		•	•	•	309741	
Armauflagen Echtleder, schwarz <i>Armrests genuine leather, black</i>		•	•	•	309742	
Armauflagen kurz, fixiert, schwarz <i>Armrests short, fixed, black</i>		•	•	•	309743	
Armauflagen kurz, 3D verstellbar, schwarz <i>Armrests short, 3D adjustable, black</i>		•	•	•	309744	
Armauflagen lang, 3D verstellbar, schwarz <i>Armrests long, 3D adjustable, black</i>		•	•	•	309745	
Armauflagen, Länge dynamisch, 3D verstellbar, schwarz <i>Armrests, dynamic length, 3D adjustable, black</i>		•	•	•	309737	



Ergolift Evolution Watch



Steuerungen | Controls

				N°	Aufpreis Surcharge
	100	120	140		
Bedienelement, Standard <i>Control, standard</i>	●	●	●	309935	–
Bedienelement mit 3 Speicherplätzen <i>Control with 3 memory keys</i>	●	●	●	309917	
Bedienelement mit Multi-Speichermöglichkeit und Bluetooth zur Anbindung der Desk Control App <i>Control with multi-memory and Bluetooth for connecting to the Desk Control App</i>	●	●	●	309918	
Kollisionsschutz-Sensor <i>Collision protection sensor</i>	●	●	●	309919	
Desk Control App (iOS und Android)	●	●	●	309920	

Ergolift Evolution Watch



Schutzscheibe

Dank der U-Form steht der Aufbau aus ESG Floatglas sicher auf dem Werkstisch. Die Kanten sind auf Gehrung UV-verklebt und poliert.

- Widerstandsfähig gegen Biegebelastungen
- Große Stoß- und Schlagfestigkeit
- Geringes Verletzungsrisiko durch „Glaskrümelbildung“

Protection washer

Thanks to the U-shape, the structure made of ESG float glass stands securely on the workbench. The edges are mitred, UV-bonded, and polished.

- Resistant to bending loads
- High impact and shock resistance
- Low risk of injury due to "glass crumb" formation

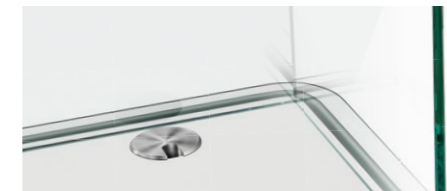

			N°	Aufpreis Surcharge
100	120	140		
●	–	–	309907	
–	●	–	309908	
–	–	●	309909	

Ergolift Evolution Watch



N° 309746



N° 309747



N° 309946

Schubladensäulen | Drawer columns

					N°	Aufpreis Surcharge
		100	120	140		
Design-Griffe <i>Design handles</i>	Aluminium <i>Aluminum</i>	-	●	●	309746	
Soft-Close Dämpfer <i>Soft-Close dampers</i>	-	●	●	●	309747	
Soft-Close Dämpfer und Vollauszug <i>Soft-Close dampers and full pullout</i>	-	-	●	●	309805	
Zentralverriegelung für Schubladen <i>Central locking for drawers</i>	-	●	●	●	309771	
Schubladenerweiterung für mehr Stauraum, 6 Schubladen links, 3 + 1 extra hohe Schublade rechts <i>Drawers extension for more storage space, 6 drawers on the left, 3 + 1 extra high drawer on the right</i>	Weiß <i>White</i>	-	●	●	309946	
	Buche <i>Beech</i>	-	●	●	309947	
	Seidengrau <i>Silk gray</i>	-	●	●	309948	

Ergolift Evolution Watch



N° 309748



N° 309811

Mittelschubladen | Central drawers

					N°	Aufpreis Surcharge
		100	120	140		
Hohe Mittelschublade mit ausziehbarem Feilbrett <i>High-rise central drawer with pull-out shelf board</i>	Weiß <i>White</i>	-	●	●	309748	
	Buche <i>Beech</i>	-	●	●	309810	
	Seidengrau <i>Silk gray</i>	-	●	●	309833	
Flache Mittelschublade <i>Low-rise central drawer</i>	Weiß <i>White</i>	-	●	●	309811	
	Buche <i>Beech</i>	-	●	●	309812	
	Seidengrau <i>Silk gray</i>	-	●	●	309941	
Hohe Mittelschublade mit ausziehbarem Feilbrett und Einsteckvorrichtung mit Feilnagel und Schraubstockhalter <i>High-rise central drawer with pull-out shelf board and insertion device with file wood and vise holder</i>	Weiß <i>White</i>	-	●	●	309959	
	Buche <i>Beech</i>	-	●	●	309960	
	Seidengrau <i>Silk gray</i>	-	●	●	309961	

Ergolift Evolution Watch



N° 309828



N° 309832

Einleger für Schubladen | Drawers inlays

						N°	Aufpreis Surcharge
	Standard	Vollauszug Full extension	100	120	140		
Gefache, variabel Dividers, variable	●	-	●	-	-	309828	
			-	●	-	309826	
			-	-	●	309768	
	-	●	-	●	-	309899	
			-	-	●	309773	
			-	●	-	309827	
Muldenplatte Trough panel	●	-	-	●	-	309827	
			-	-	●	309797	
	-	●	-	●	-	309900	
			-	-	●	309774	
	Mittelschublade Central drawer		-	●	●	309832	

Anwendungsbeispiele | Application examples

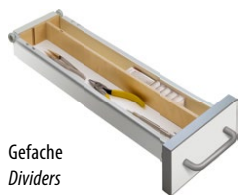

Gefache
Dividers



Muldenplatten
Trough panels



... für Mittelschubladen
... for central drawers

Ergolift Evolution Watch

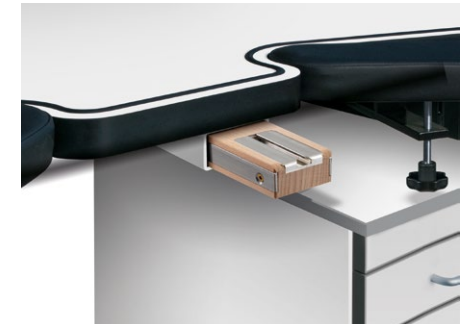

Einsteckvorrichtung | Insertion device

					N°	Aufpreis Surcharge	
		100	120	140			
Kombi-Einsteckvorrichtung mit Feilholz und Schraubstockhalter Combination insertion device with file wood and vise holder		Wei White	●	●	●	309636	
		Anthrazit Anthracite	●	●	●	309662	
		Schwarz Black	●	●	●	309663	

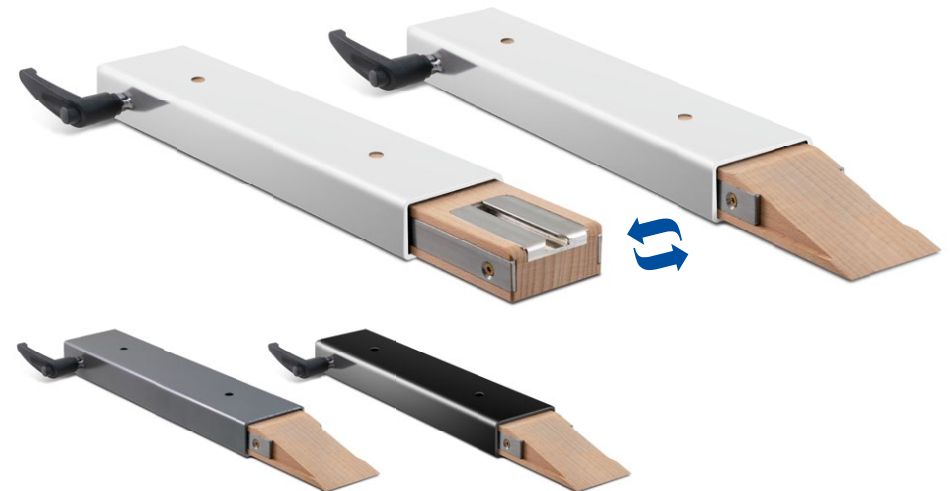

Ergolift Evolution Watch



N° 309822



N° 309818

Zusätzlicher Stauraum Additional storage space

					N°	Aufpreis Surcharge
		100	120	140		
Ausziehbares Tablar für Tastaturen <i>Pull-out shelf for keyboards</i>	Weiß <i>White</i>	–	●	●	309822	
	Buche <i>Beech</i>	–	●	●	309823	
	Seidengrau <i>Silk gray</i>	–	●	●	309825	
Halterung für Monitore bis 34" <i>Mount for monitors up to 34"</i>	Schwarz <i>Black</i>	–	●	●	309901	
Regalaufsatz, schwebend <i>Shelf top, floating</i>	Weiß <i>White</i>	–	●	●	309955	
	Buche <i>Beech</i>	–	●	●	309957	
	Eiche <i>Oak</i>	–	●	●	309956	
Schubladenerweiterung für mehr Stauraum, 6 Schubladen links, 3 + 1 extra hohe Schublade rechts <i>Drawers extension for more storage space, 6 drawers on the left, 3 + 1 extra high drawer on the right</i>	Weiß <i>White</i>	–	●	●	309946	
	Buche <i>Beech</i>	–	●	●	309947	
	Seidengrau <i>Silk gray</i>	–	●	●	309948	

Ergolift Evolution Watch



					N°	Aufpreis Surcharge
		100	120	140		
Ablageplatte mit 2 Kabeldurchlässen <i>Storage shelf with 2 cable passages</i>	Weiß <i>White</i>	●	–	–	309793	
		–	●	–	309794	
		–	–	●	309795	
	Buche <i>Beech</i>	●	–	–	309813	
		–	●	–	309814	
		–	–	●	309815	
	Seidengrau <i>Silk gray</i>	●	–	–	309913	
		–	●	–	309914	
		–	–	●	309915	
Rückwand, gedoppelt zur Kabelführung <i>Back panel, doubled for cable routing</i>	Weiß <i>White</i>	●	–	–	309816	
		–	●	–	309817	
		–	–	●	309818	
	Buche <i>Beech</i>	●	–	–	309819	
		–	●	–	309820	
		–	–	●	309821	
	Seidengrau <i>Silk gray</i>	●	–	–	309910	
		–	●	–	309911	
		–	–	●	309912	



N° 309794



Ergolift Evolution

Waldmann Taneo

Die Werktschleuchte Taneo ist ein wahres Universal-talent. Mit anwendungsgerechter Lichtleistung, hoher Lichtqualität und ergonomischem Handling sorgt sie für optimale Arbeitsbedingungen und lässt sich an individuelle Anforderungen anpassen.

The Taneo workbench luminaire is a true universal talent. With application-oriented light output, high lighting quality and ergonomic handling, it ensures optimum working conditions and can be adapted to individual requirements.



	Farbtemperatur Color temperature	Leistung Output	Gestänge Arm	Blende Screen	N°	Listenpreis List price
STZL 12 R ↔ 218 mm	4 000 K	14 W	Lang Long		307730	
	4 000 K				307730W	
STZL 24 R ↔ 389 mm	4 000 K	24 W	Lang Long		307733	
	4 000 K				307733W	
	5 000 K	24 W	Kurz Short		307735	
	5 000 K				307739	
	5 000 K				307739W	
STZL 24 AR (ESD)	5 000 K				307746	
STZL 36 R ↔ 577 mm	4 000 K	34 W	Lang Long		307736	
	4 000 K				307736W	
	5 000 K	34 W	Kurz Short		307738	

Ergolift Evolution



[www](#) Mehr? Webshop!
More? Webshop!

Luft-Vakuum-Verteiler | Air-vacuum-distributors

		N°	Listenpreis List price
2 Ausgänge Outlets		220115	
3 Ausgänge Outlets		220116	
4 Ausgänge Outlets		220117	
2 Ausgänge Outlets		220421	
3 Ausgänge Outlets		220422	
4 Ausgänge Outlets		220423	
Handstück für Druckluft, 45° gekröpft Handpiece for compressed air, cranked by 45°		220215	
		220215A	
Handstück für Vakuum, 45° gekröpft Handpiece for vacuum, cranked by 45°		220426	
		220426A	
Drehbarer Stutzen für Arbeitsplatten mit mindestens 22 mm Stärke Rotatable socket for benchtops with a minimum thickness of 22 mm		220424	
Drehbarer Stutzen für Arbeitsplatten mit 30 – 40 mm Stärke Rotatable socket for benchtops with a thickness of 30 – 40 mm		220425	

www.beco-technic.com



Beco Technic Onlineshop

Neuer Look, neue Features!

New look, new features!

ERGOLIFT EVOLUTION GOLD



Werkzeuge und Sonderausstattungen für Goldschmiede
Workbenches and optional equipments for goldsmiths

Ergolift Evolution Gold



Integrierter Adapter für Arbeitsplatzleuchten
Integrated adapter for task luminaires

Schutzscheibe aus ESG Floatglas
Protection washer made of ESG float glass

Umlaufende Rillen oder Kanten zum Auffangen von Kleinteilen
Circumferential grooves or raised edges for catching small parts

Verschiedene Bedienelemente und App Steuerung
Various controls and app control

Strapazierfähige Massivholzplatten, lackiert oder geölt
Durable solid wood benchtops, lacquered or oiled

Schubladen mit Soft-Close-Dämpfern, Vollauszug, Zentralverriegelung und unterschiedlichen Einteilungsmaterialien
Drawers with soft-close dampers, full-extension, central locking, and various dividing materials

Rückwärtiges Fach unter der Tischplatte und doppelte Rückwand zur Kabelführung
Rear panel beneath the benchtop and double back panel for cable routing

Ablageplatten, Schubladenerweiterungen und Mittelschubladen für mehr Stauraum und bessere Arbeitsabläufe
Storage shelves, drawer extensions, and central drawers for more storage space and improved workflows

Adapter für Haltwerkzeuge (GRS BenchMate)
Adapter for holding tools (GRS BenchMate)

Ergolift Evolution Gold



Basismodelle

Bereits die Basismodelle des Ergolift Evolution sind mit vielen Komponenten ausgestattet:

- Elektrische Höhenverstellung
- Kabelführung unter der Arbeitsplatte
- Integrierter Werkbrettschoner
- Eingelassener Adapter für Haltwerkzeuge (GRS BenchMate)
- Fräsung und Aufkantung zum Auffangen von Kleinteilen

Basic models

Even the basic models of the Ergolift Evolution are equipped with many components:

- Electrical height adjustment
- Cable routing beneath the benchtop
- Built-in workbench protector
- Recessed adapter for holding tools (GRS BenchMate)
- Grooves and raised edges for catching small parts

MORE THAN A FEELING

Ergolift Evolution Gold



Elektrisch höhenverstellbar

Schon die Basismodelle verfügen über die elektrische Höhenverstellung. Über ein Steuerelement, das an der Unterseite der Tischplatte angebracht ist, wird die Höhe mühelos, stufenlos und ruckel-frei verstellt.

Der elektrische Antrieb verzichtet aus Sicherheitsgründen auf eine Antriebswelle unter der Arbeitsplatte und überzeugt durch eine fünfjährige Gewährleistung auf Herstellungsfehler.

Electrically height adjustable

Even the basic models feature electric height adjustment. A control element mounted on the underside of the benchtop adjusts the height effortlessly, continuously, and smoothly.

For safety reasons, the electric drive does not have a driveshaft under the benchtop and comes with a five-year warranty against manufacturing defects.

LIFT ME UP

90 - 156 cm

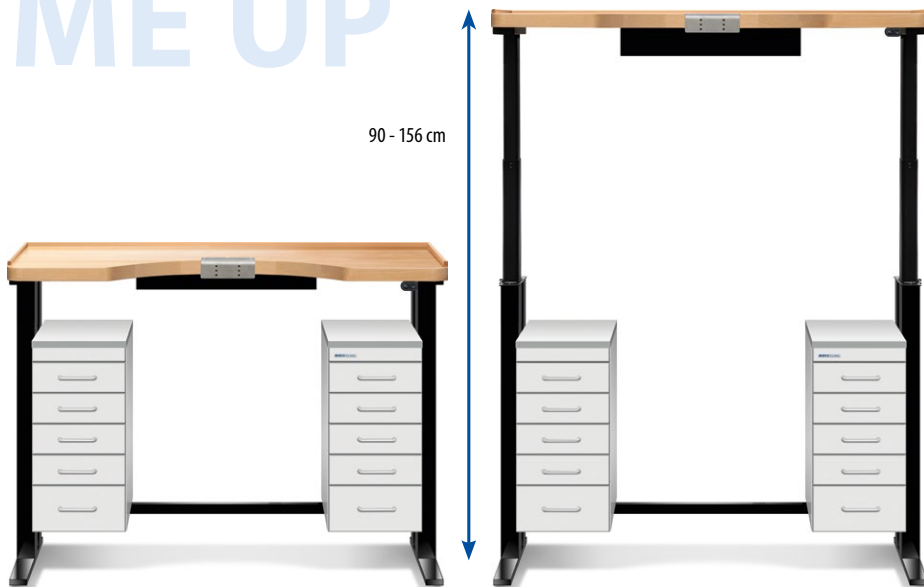

Ergolift Evolution Gold



				Gestell Frame	N°	Listenpreis List price
120 cm	140 cm	26 x 53 cm	35 x 53 cm			
				Schwarz Black	309891	
					309890	
				Buche Beech	309896	
					309895	



Ergolift Evolution Gold



Arbeitsplatten mit herausnehmbarer Einlegeplatte Bench top with removable insert plate



			N°	Aufpreis Surcharge
	120	140		
Buche Beech	•	–	309849	
	–	•	309850	

Ergolift Evolution Gold



Mittelschubladen | Central drawers

				N°	Aufpreis Surcharge
		120	140		
Doppelsystem, Mittelschublade Material- und Feilschublade, beide mit Softstop-Belag <i>Double system, central drawer</i> Material and filing drawer, both with softstop coating	Buche Beech	•	•	309916	
Hohe Mittelschublade mit ausziehbarem Feilbrett High-rise central drawer with pull-out shelf board		•	•	309810	
Flache Mittelschublade Low-rise central drawer		•	•	309812	

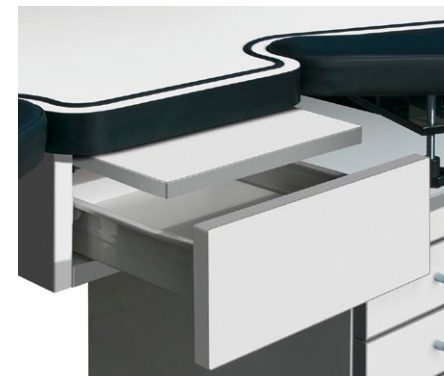

N° 309748



N° 309811

Ergolift Evolution Gold



N° 309746



N° 309747



N° 309946

Schubladensäulen | Drawer columns

				N°	Aufpreis Surcharge
		120	140		
Design-Griffe <i>Design handles</i>	Aluminium <i>Aluminum</i>	●	●	309746	
Soft-Close Dämpfer <i>Soft-Close dampers</i>	-	●	●	309747	
Soft-Close Dämpfer und Vollauszug <i>Soft-Close dampers and full pullout</i>		●	●	309805	
Zentralverriegelung für Schubladen <i>Central locking for drawers</i>	-	●	●	309771	
Schubladenerweiterung für mehr Stauraum, 6 Schubladen links, 3 + 1 extra hohe Schublade rechts <i>Drawers extension for more storage space, 6 drawers on the left, 3 + 1 extra high drawer on the right</i>	Weiß <i>White</i>	●	●	309946	
	Buche <i>Beech</i>	●	●	309947	

Ergolift Evolution Gold



N° 309773



N° 309832

Einleger für Schubladen | Drawers inlays

					N°	Aufpreis Surcharge
	Standard	Vollauszug <i>Full extension</i>	120	140		
Gefache, variabel <i>Dividers, variable</i>	●	-	●	-	309826	
	-	-	-	●	309768	
	-	●	●	-	309899	
	-	-	-	●	309773	
Muldenplatte <i>Trough panel</i>	●	-	●	-	309827	
	-	-	-	●	309797	
	-	●	●	-	309900	
	-	-	-	●	309774	
	Mittelschublade <i>Central drawer</i>		●	●	309832	

Anwendungsbeispiele | Application examples



Gefache
Dividers



Muldenplatte
Trough panel



... für Mittelschubladen
... for central drawers

Ergolift Evolution Gold



Ergolift Evolution Gold



Zusätzlicher Stauraum Additional storage space

				N°	Aufpreis Surcharge
		120	140		
Ablageplatte mit 2 Kabeldurchlässen <i>Storage shelf with 2 cable passages</i>	Weiß <i>White</i>	●	–	309794	
		–	●	309795	
	Buche <i>Beech</i>	–	–	309813	
		●	–	309814	
		–	●	309815	
		–	–	309817	
Rückwand, gedoppelt zur Kabelführung <i>Back panel, doubled for cable routing</i>	Weiß <i>White</i>	–	●	309818	
		–	–	309819	
	Buche <i>Beech</i>	●	–	309820	
		–	●	309821	
		●	●	309955	
		●	●	309957	
Schubladenerweiterung für mehr Stauraum, 6 Schubladen links, 3 + 1 extra hohe Schublade rechts <i>Drawers extension for more storage space, 6 drawers on the left, 3 + 1 extra high drawer on the right</i>	Weiß <i>White</i>	●	●	309946	
		●	●	309947	
	Schwarz <i>Black</i>	●	●	309901	
		●	●	309901	



Ergolift Evolution Gold



Schutzscheibe

Dank der U-Form steht der Aufbau aus ESG Floatglas sicher auf dem Werk Tisch. Die Kanten sind auf Gehrung UV-verklebt und poliert.

- Widerstandsfähig gegen Biegebelastungen
- Große Stoß- und Schlagfestigkeit
- Geringes Verletzungsrisiko durch „Glaskrümelbildung“

Protection washer

Thanks to the U-shape, the structure made of ESG float glass stands securely on the workbench. The edges are mitred, UV-bonded, and polished.

- Resistant to bending loads
- High impact and shock resistance
- Low risk of injury due to "glass crumb" formation

		N°	Aufpreis Surcharge
120	140		
•	–	309908	i@
–	•	309909	



Ergolift Evolution Gold



Steuerungen | Controls

			N°	Aufpreis Surcharge
	120	140		
Bedienelement, Standard <i>Control, standard</i>	•	•	309935	–
Bedienelement mit 3 Speicherplätzen <i>Control element with 3 memory keys</i>	•	•	309917	i@
Bedienelement mit Multi-Speichermöglichkeit und Bluetooth zur Anbindung der Desk Control App <i>Control with multi-memory and Bluetooth for connecting to the Desk Control App</i>	•	•	309918	
Kollisionsschutz-Sensor <i>Collision protection sensor</i>	•	•	309919	
Desk Control App (iOS und Android)	•	•	309920	

Ergolift Evolution Beistellmöbel

FILL
ME
UP
BUTTER
CUP



N° 309936



N° 309937



N° 309938

Ergolift Evolution side furniture

Schubladencontainer

Ergolift Evolution Schubladencontainer, inkl. einem Materialauszug und 3 Schubladen mit Vollauszug und Soft-Close-Mechanik, Zentralverriegelung und Ablagefläche mit umlaufenden Hartgummiprofil zum Auffangen von Kleinteilen.

Die Schubladen sind leichtgängig und lassen sich nahezu geräuschlos öffnen und schließen.

Die hochwertigen versteckten Rollen eignen sich für harte und weiche Fußböden.

Drawer containers

Ergolift Evolution drawer container, incl. 1 material drawer and 3 drawers with full extension and soft-close-mechanism, central locking and storage surface with circumferential hard rubber profile for catching small parts.

The drawers are smooth-running and can be opened and closed almost silently.

The high quality hidden rollers are suitable for hard and soft floors.



		N°	Listenpreis List price
<input type="checkbox"/>	Weiß White	309936	
<input type="checkbox"/>	Buche Beech	309937	
<input type="checkbox"/>	Seidengrau Silk gray	309938	

Ergolift Evolution Beistellmöbel

STAND
BY ME

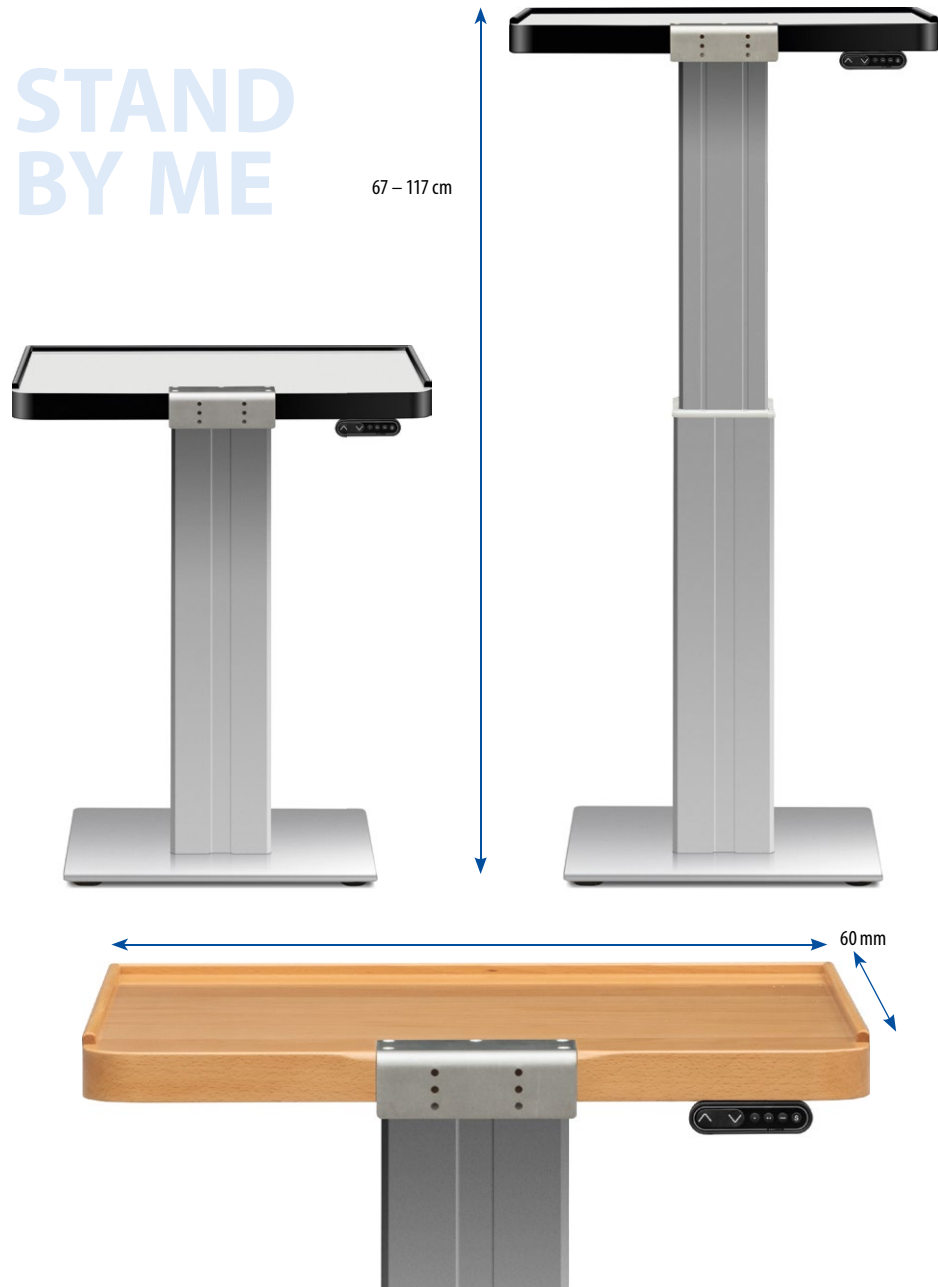

Ergolift Evolution side furniture



Arbeitsstation

Die Ergolift Arbeitsstation ist ein frei stehender Arbeitsplatz, der sich zum Beispiel für die Qualitätskontrolle, Politur, Graveure und Steinsetzer eignet.

Sie bietet ausreichend Platz für ein Mikroskop, ein pneumatisches Graviersystem, einen Mikromotor oder ein Punktschweißgerät.

Die Ergolift Arbeitsstation ist elektrisch höhenverstellbar und bietet zusätzlich die Möglichkeit 3 unterschiedliche Arbeitshöhen zu speichern.

Die eingelassene BenchMate-Tischhalte mechanik erlaubt das einfache Einhängen einer Graviersäge, eines Feilnagels oder anderer Haltewerkzeuge.

	N°	Listenpreis List price
 Weiß White	309729	



Workstation

The Ergolift workstation is a freestanding workplace perfect for quality control, polishing, engravers, and stone setters.

It offers sufficient space for a microscope, a pneumatic engraving system, a micromotor, or a spot welder.

The Ergolift workstation is electrically height-adjustable and also offers the option of storing 3 different working heights.

The recessed BenchMate holding mechanism allows an engraving ball, file nail, or other holding tools to be easily attached.

	N°	Listenpreis List price
 Buche Beech	309728	

Anwendungsbeispiele | Application examples



Ergolift Evolution



[www](#) Mehr? Webshop!
More? Webshop!

	N°	Listenpreis List price
Tevisio Lupenleuchte <i>Tevisio magnifier luminaire</i>	313184	
Ring LED Lupenleuchte <i>Ring LED magnifier luminaire</i>	313176	
Schreibtischleuchte Para.Mi <i>Desk luminaire Para.Mi</i>	307644	

Ergolift Evolution



Stehleuchten

Diese stylischen Leuchten sorgen für perfekte Beleuchtung am Arbeitsplatz oder für Ambiente auf der Verkaufsfläche.

Free standing luminaires

These stylish luminaires provide perfect lighting at the desk or for ambience on the sales floor.

	N°	Listenpreis List price
Lavigo Twin-U	307647	
Vivaa Free Metal	307645	
Vivaa Free Wood	307646	

Ergolift Evolution

TSL-Escha LED Leuchten



Diese Gelenkarmleuchten leuchten die Arbeitsfläche hell, blend- und nahezu schattenfrei aus. Zudem lässt sich nicht nur die Helligkeit, sondern auch die Farbtemperatur stufenlos und individuell einstellen.

TSL-Escha LED luminaires

These articulated arm luminaires illuminate the work surface brightly, glare-free and virtually shadow-free. In addition, not only the brightness, but also the color temperature can be adjusted continuously and individually.

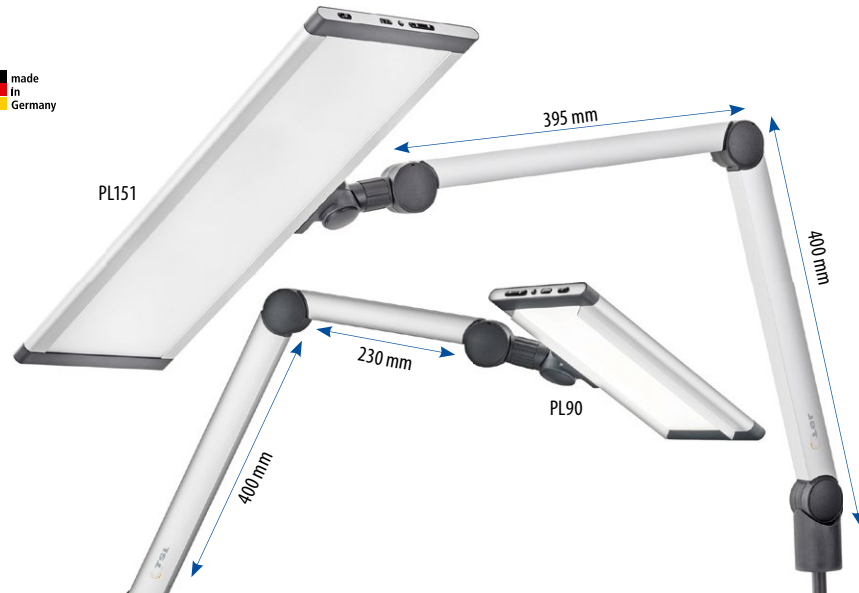
made
in
Germany



	Farbtemperatur Color temperature	Gestänge Arm	Befestigung Mounting	Netzteil Power supply	N°	Listenpreis List price
PL151 X3 ↔ 304 mm	 3000 – 6000 K	Lang Long	Separat erhältlich Sold separately	Separat erhältlich Sold separately	307800	
PL151 X6 ↔ 564 mm					307802	
PL90 ↔ 307 mm		Kurz Short	Unizwinge Universal clamp	Enthalten Included	307804	
	Bohrschraubbefestigung Drilling screw fitting	307805				
	Aufschraubbefestigung Screw-on fixture	307806				

www.beco-technic.com



Saubere Sache Neat and clean

Alles aus einer Hand ist einfach einfacher. Darum bieten wir Ihnen jetzt auch verschiedenste Putzmittel, Reiniger und Verbrauchsartikel für Küche, Sanitär und natürlich den Verkaufsraum an.

Everything from a single source is simply easier. That's why we now also offer you a wide variety of cleaning products, detergents and consumables for the kitchen, sanitary facilities and, of course, the sales floor.



BECOTECHNIC

Beco Technic GmbH

21500 Geesthacht | Germany

Tel. +49 4152 809680

www.beco-technic.com

Ihre individuellen Einkaufspreise finden Sie online.
Änderungen vorbehalten. Stand 03.2022.

*You can find your individual purchase prices online.
Subject to change. Update 03.2022.*



Sammelordner
Collective folder
N° 1000